

Automatic sliding door system

ASSA ABLOY Slim

ASSA ABLOY
Entrance Systems

The global leader in
door opening solutions



The ASSA ABLOY Slim series includes:

- ASSA ABLOY Slim
- ASSA ABLOY Slim Eco
- ASSA ABLOY Slim Telescopic
- ASSA ABLOY Slim Eco Telescopic
- ASSA ABLOY Slim Break-Out
- ASSA ABLOY Slim Reverse Break-Out

ASSA ABLOY Slim & ASSA ABLOY Slim Eco

The system consists of doors with slim line aluminium profiles, operator, safety units and, if required, side screens and overlights. Available for beam- or wall mounting and supplied as bi-parting and single-sliding, all models can be tailored to individual customer requirements, suitable for decorative and functional entrances.

ASSA ABLOY Slim Telescopic & ASSA ABLOY Slim Eco Telescopic

Telescopic maximizes the opening width of narrow passages, providing an impressive solution when space is limited.

ASSA ABLOY Slim Break-Out & ASSA ABLOY Slim Reverse Break-Out

Break-out enables the doors and side screens to swing outward in an emergency, allowing exit through the entire door and side-screen space.

Accessories and Options

Profile type:

- Slim
- Slim Eco

Profile finish:

- anodized aluminium, colour on request
- painted in colour according to RAL card

Glass type:

- 8, 10 or 12 mm laminated
- 8, or 10 mm tempered
- 22 mm insulated (Slim Eco profile only)

Glass finish: clear, green, bronze, opaque

Overlight (beam mounted only)

Side screens

Mechanical lock

Reverse break-out performs the same way with the doors swinging inward. Especially suitable for indoor applications.

Safety features

An integrated activation and presence detection system enhances safety for users by detecting people or objects in the doorway, preventing the door from closing until it is safe to do so.

Sustainability

ASSA ABLOY's automatic door systems can reduce the amount of energy needed to heat or cool a building, resulting in lower costs and a smaller carbon footprint for customers. The ASSA ABLOY Slim series can be fitted with optional extra tight-fitting brushes and additional sensors for fine-tuning opening and closing times, further enhancing its energy-saving capabilities. Regular maintenance helps insure top performance and extends the life of the equipment, reducing its impact on the environment.

ASSA ABLOY Slim

ASSA ABLOY SL500

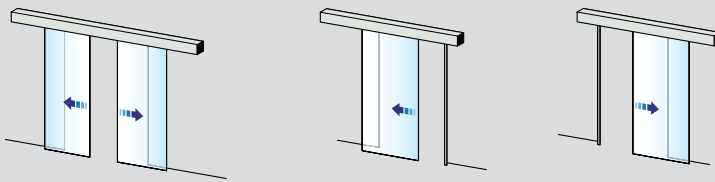
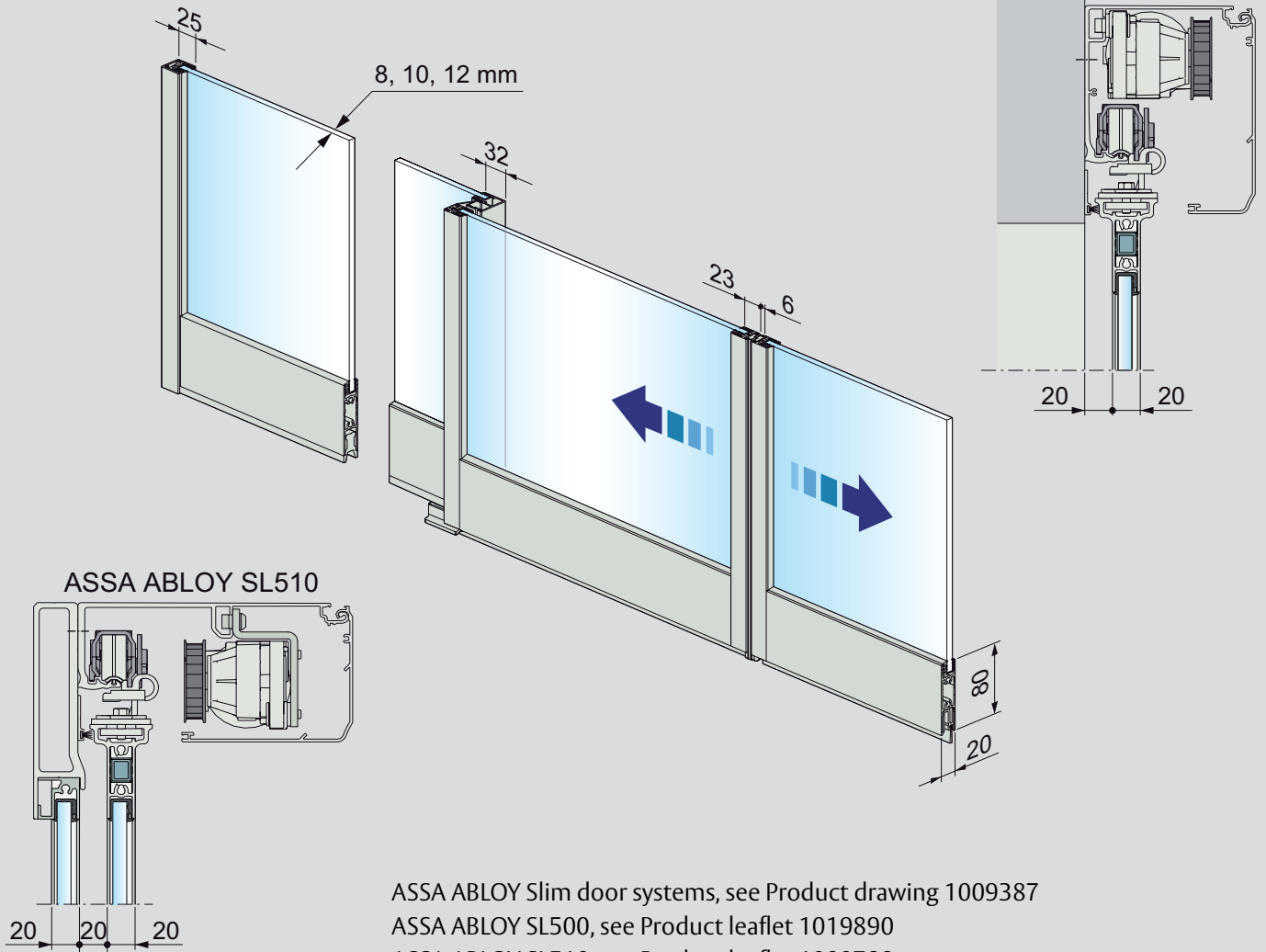

Wall mounted, only doors

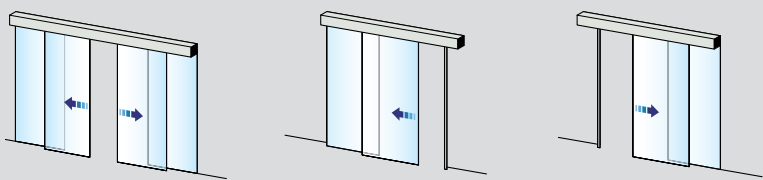

Wall mounted, doors and side screens

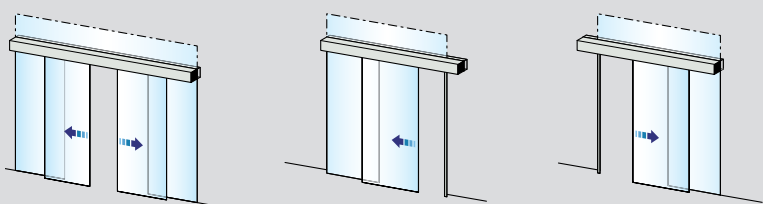

Beam mounted, doors and side screens
(option overhead)

ASSA ABLOY Slim Eco

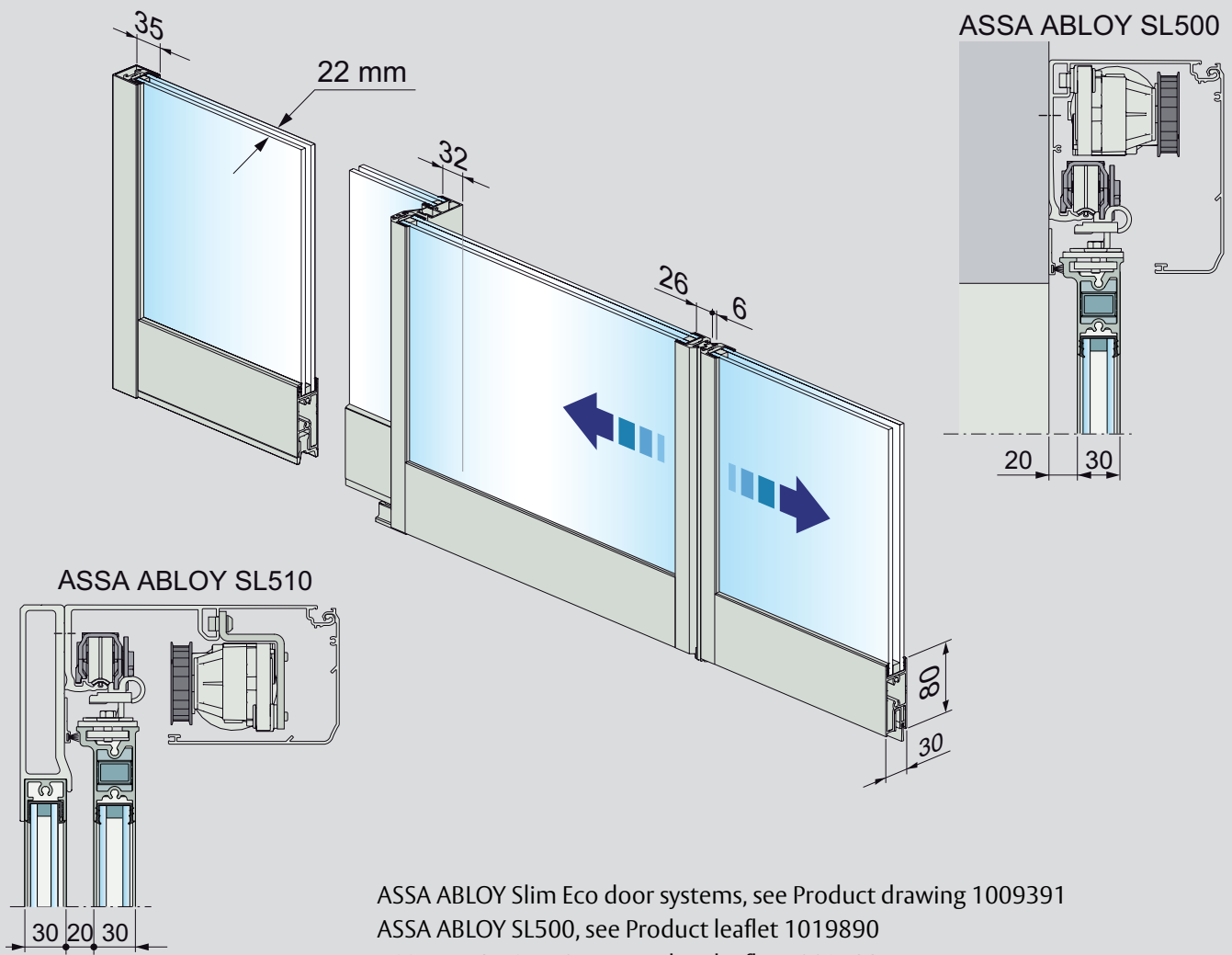

ASSA ABLOY Slim Eco door systems, see Product drawing 1009391

ASSA ABLOY SL500, see Product leaflet 1019890

ASSA ABLOY SL510, see Product leaflet 1009788

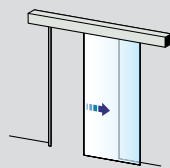
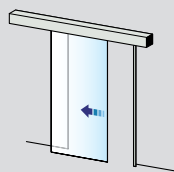
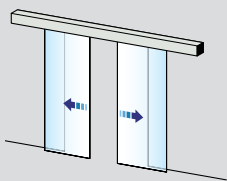

Wall mounted, only doors

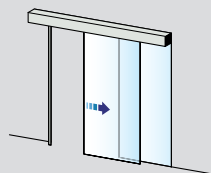
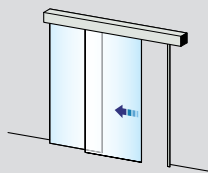
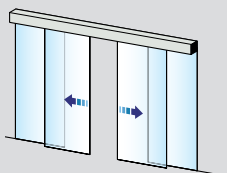

Wall mounted, doors and side screens

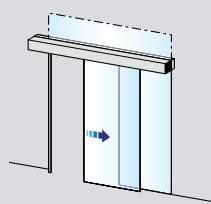
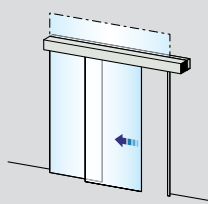
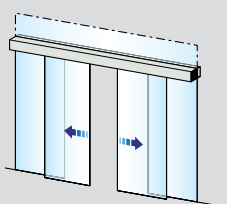

Beam mounted, doors and side screens
(option overhead)

ASSA ABLOY Slim Telescopic

ASSA ABLOY SL520

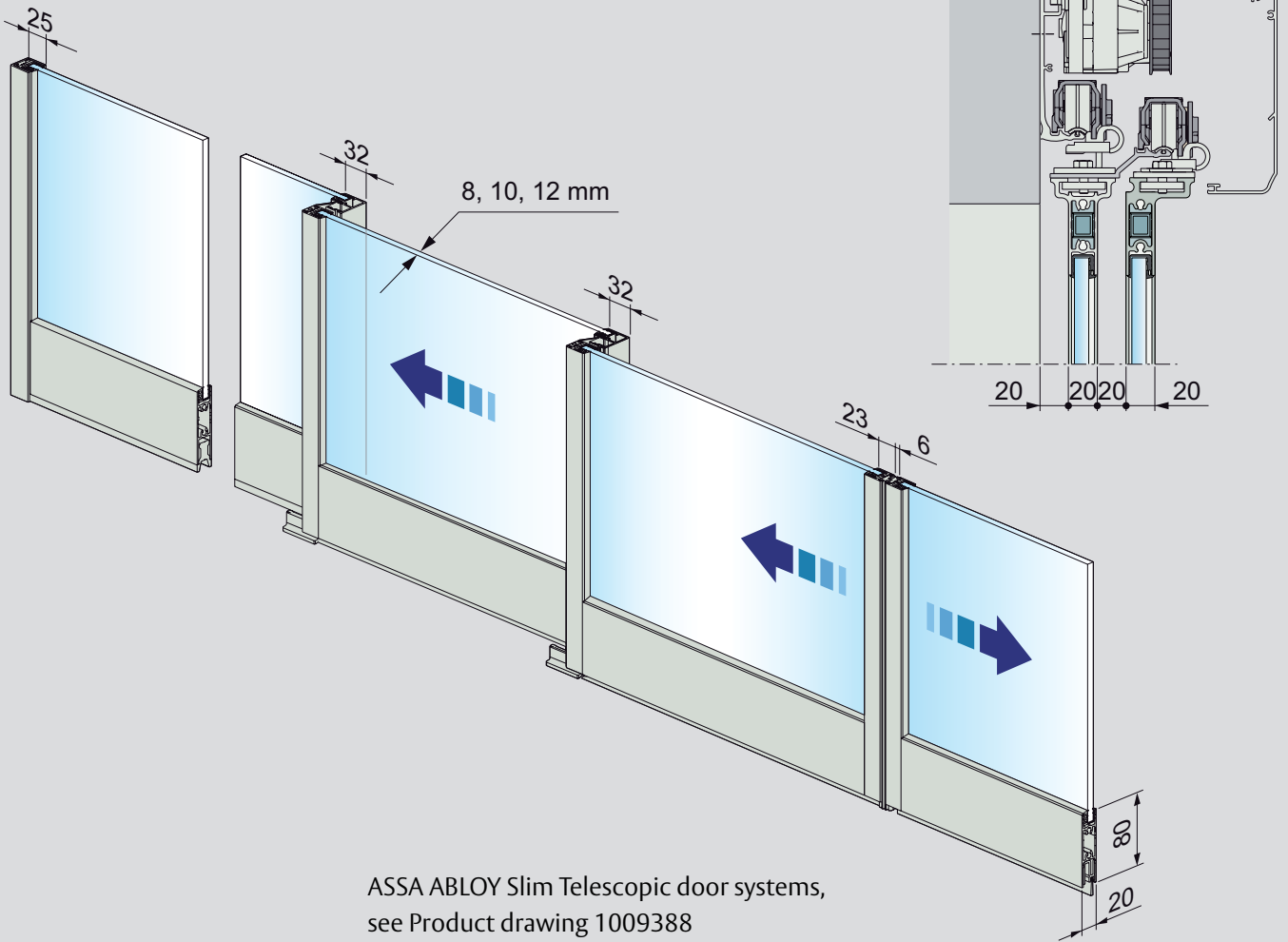

ASSA ABLOY Slim Telescopic door systems,
see Product drawing 1009388
ASSA ABLOY SL520, see Product leaflet 1009199

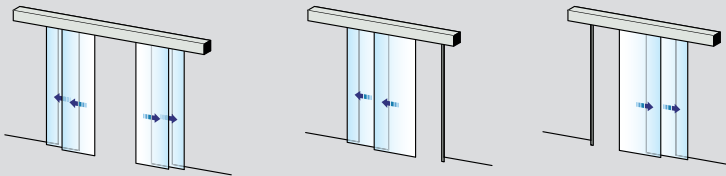

Wall mounted, only doors

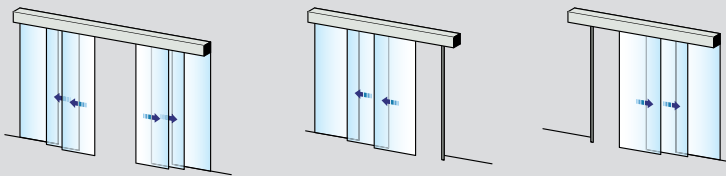

Wall mounted, doors and side screens

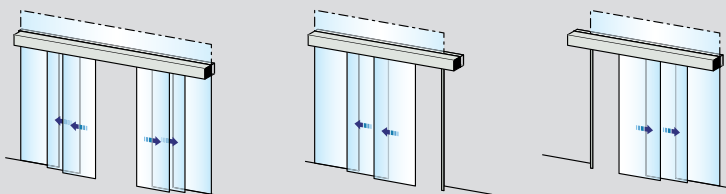

Beam mounted, doors and side screens
(option overhead)

ASSA ABLOY Slim Eco Telescopic

ASSA ABLOY SL520

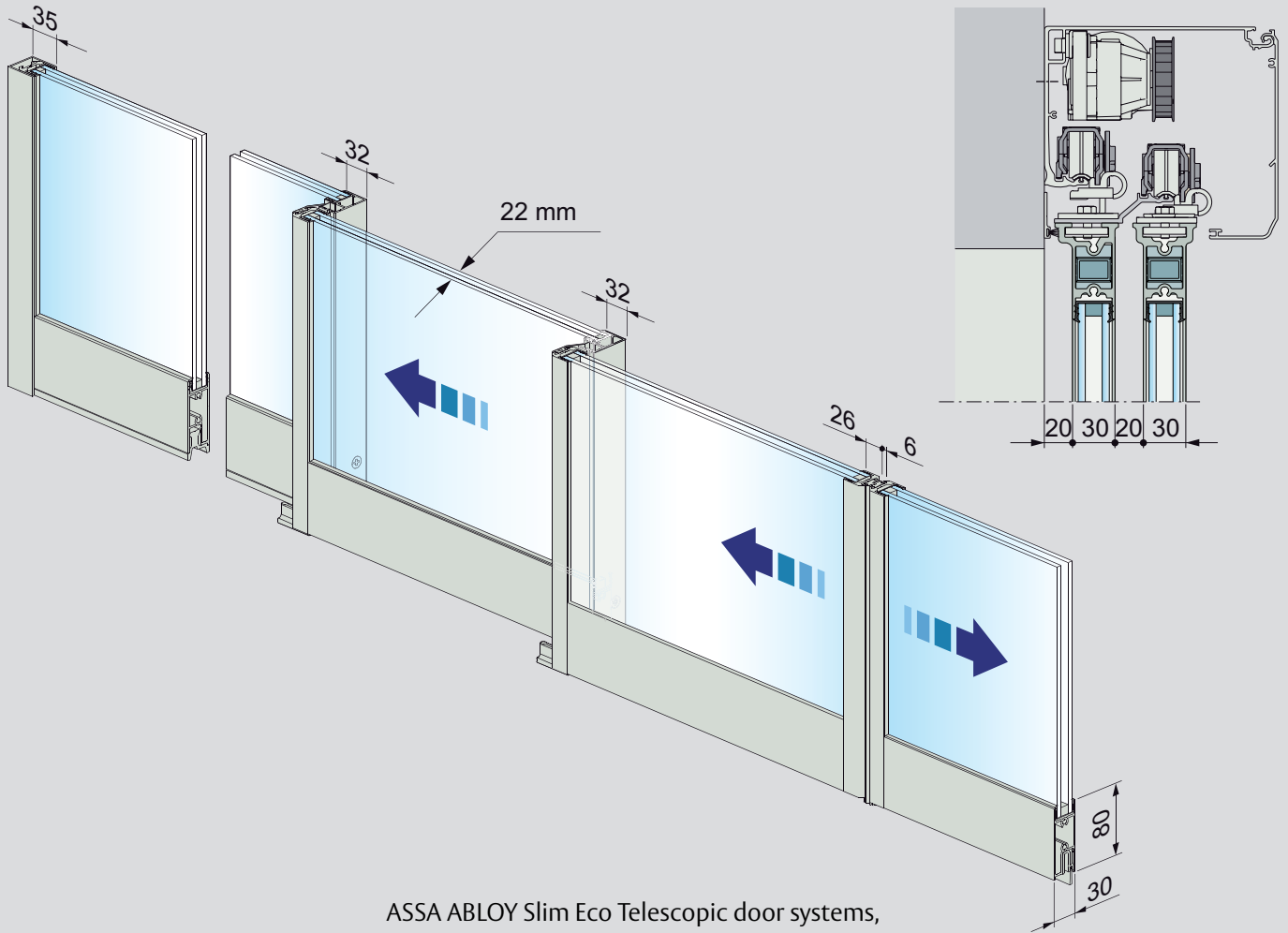

ASSA ABLOY Slim Eco Telescopic door systems,
see Product drawing 1009392
ASSA ABLOY SL520, see Product leaflet 1009199

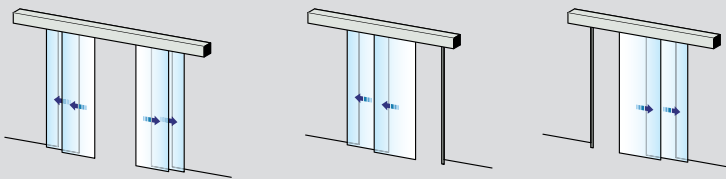

Wall mounted, only doors

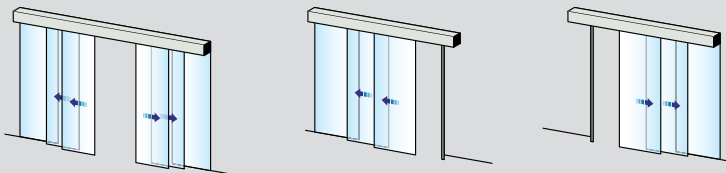

Wall mounted, doors and side screens

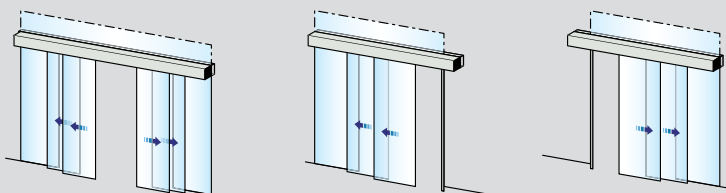

Beam mounted, doors and side screens
(option overhead)

ASSA ABLOY Slim Break-Out

ASSA ABLOY SL500

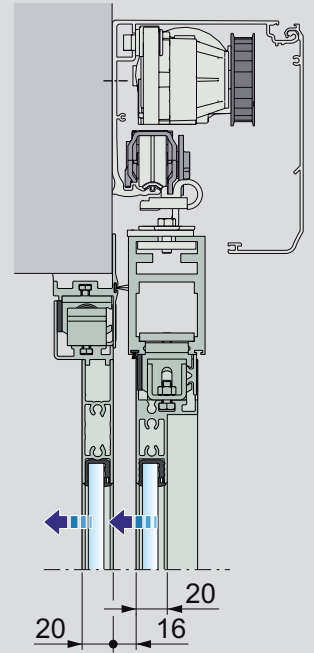
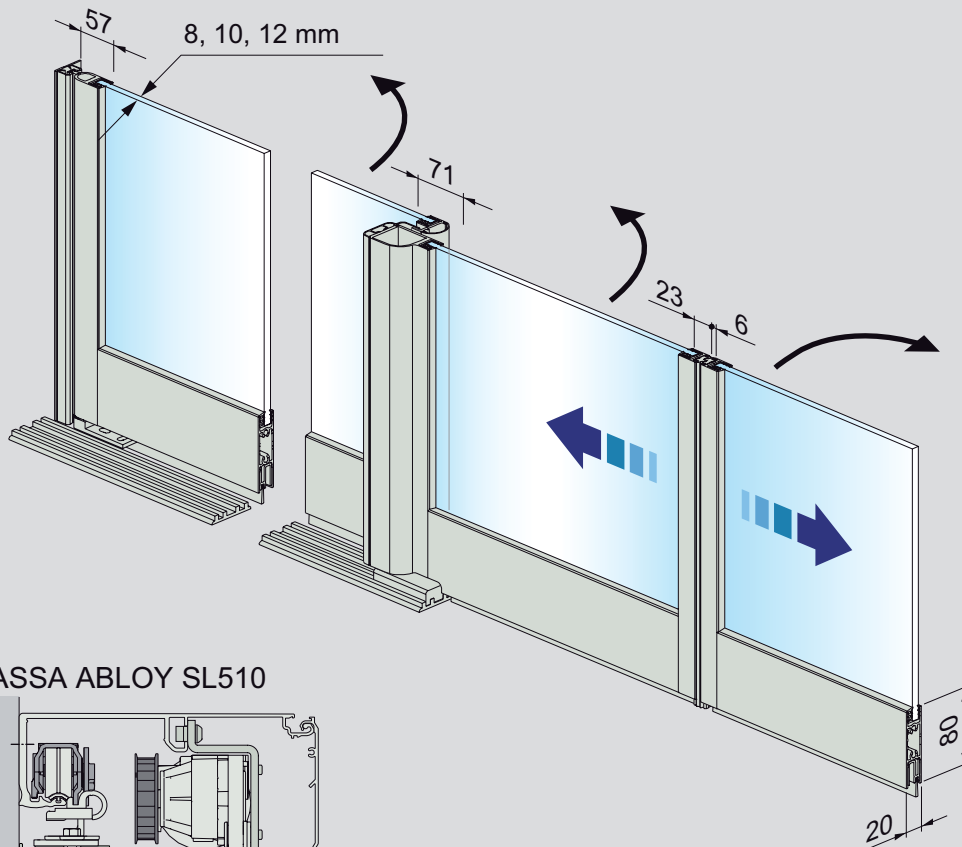

ASSA ABLOY SL510

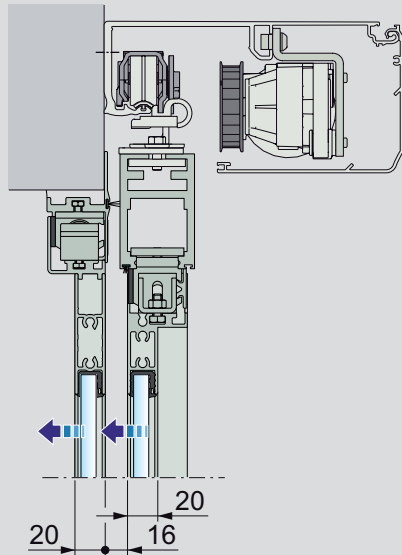

ASSA ABLOY Slim Break-Out door systems, see Product drawing 1009389

ASSA ABLOY SL500, see Product leaflet 1019890

ASSA ABLOY SL510, see Product leaflet 1009788

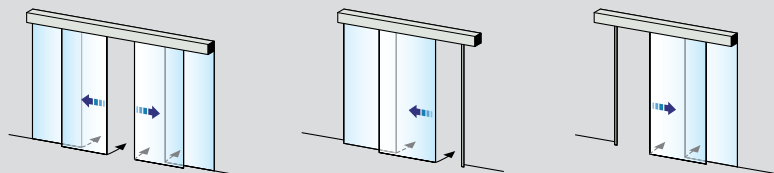

Wall mounted, doors and side screens

ASSA ABLOY Slim Reverse Break-Out

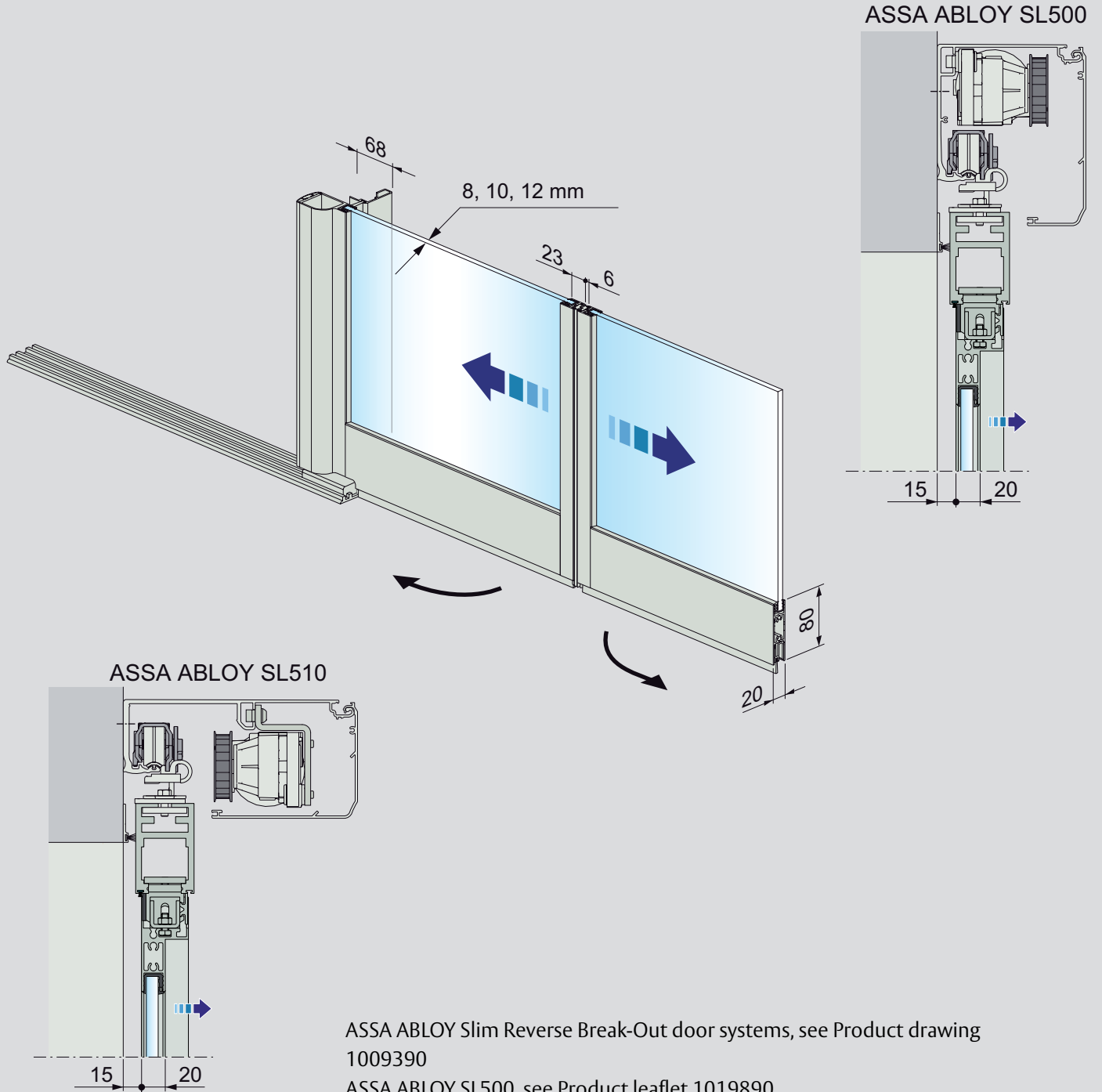

ASSA ABLOY Slim Reverse Break-Out door systems, see Product drawing 1009390

ASSA ABLOY SL500, see Product leaflet 1019890

ASSA ABLOY SL510, see Product leaflet 1009788

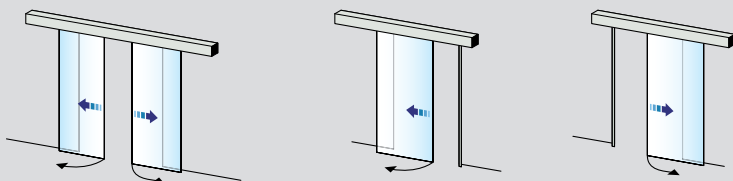

Wall mounted, only doors



This equipment should be installed, regularly inspected, maintained and serviced by trained and authorized personnel. Preventive maintenance plans are highly recommended for a proper and safe operation. Talk to your ASSA ABLOY Entrance Systems representative to learn more about our service offering!