

High speed door

ASSA ABLOY HS9110P

ASSA ABLOY
Entrance Systems

Experience a safer
and more open world



Medium-sized high speed door for inside applications with enhanced drive system

The ASSA ABLOY HS9110P is an evolution of the ASSA ABLOY HS9010P. The enhanced drive system gives increased durability and comfort. The main features of the ASSA ABLOY HS9110P are:

- Medium-sized, max. 5500 x 5500 mm
- Heavy-duty operations
- Inside usage
- Galvanised steel construction
- Unique enhanced direct door drive system
- Opening speed up to 2,4 m/s

The fast opening and closing speed improves your traffic flow, provides employee comfort, and saves energy. The unique dual barrel power drive system eliminates the need for weighted bottom bars or tension systems by actively driving the door curtain. The curtain retention belt technology creates an excellent draft seal and pressure resistance. Exceptional reliability and smooth operation is ensured by a frequency converter driven motor for a soft start and stop.

The reliable and versatile control unit ensures precise door set up and diagnostics and is enclosed in a robust steel control box. A customer friendly clear display offers a wide range of information like an easy to read cycle counter.

Break-away and Automatic Reset system

ASSA ABLOY high speed doors are equipped with a break-away and automatic reset system. The curtain reintroduces itself after a crash to reduce downtime and maintenance.

Completely safe

Features that make our doors completely safe.

- The soft bottom profile has no rigid parts, it gives way should an obstruction be in the line of closing.
- If the door is hit, the fabric curtain absorbs the impact and releases itself from its side guides without causing damage or being damaged itself.

Windows, vision panels and insect screens

To increase the admission of daylight, visibility or airflow the door curtain can be equipped with windows, vision panels or insect screens. These options are offered in fixed layouts.

Insulated curtain

An insulated curtain with an increased static insulation of 2,41 W/(m²K) is available as an option.

Technical Data

Min size (W x H)	1000 x 2000 mm
Max size (W x H) ¹	5500 x 5500 mm
Operating speed ²	opening: up to 2,4 m/s closing: 1,2 m/s
Wind load resistance ³ , EN 12424	class 1 (300 N/m ²)
Water penetration ³ , EN 12425	class 2 (50 N/m ²)
Air permeability ³ , EN 12426	class 1 (24 m ³ /m ² /h at 50 Pa)
Thermal transmittance	6,02 W/(m ² K)
Performance Test	1.000.000 cycles

1) Other sizes available on request 2) Depending on door size
3) Not applicable for insect screens

Dimensional specifications

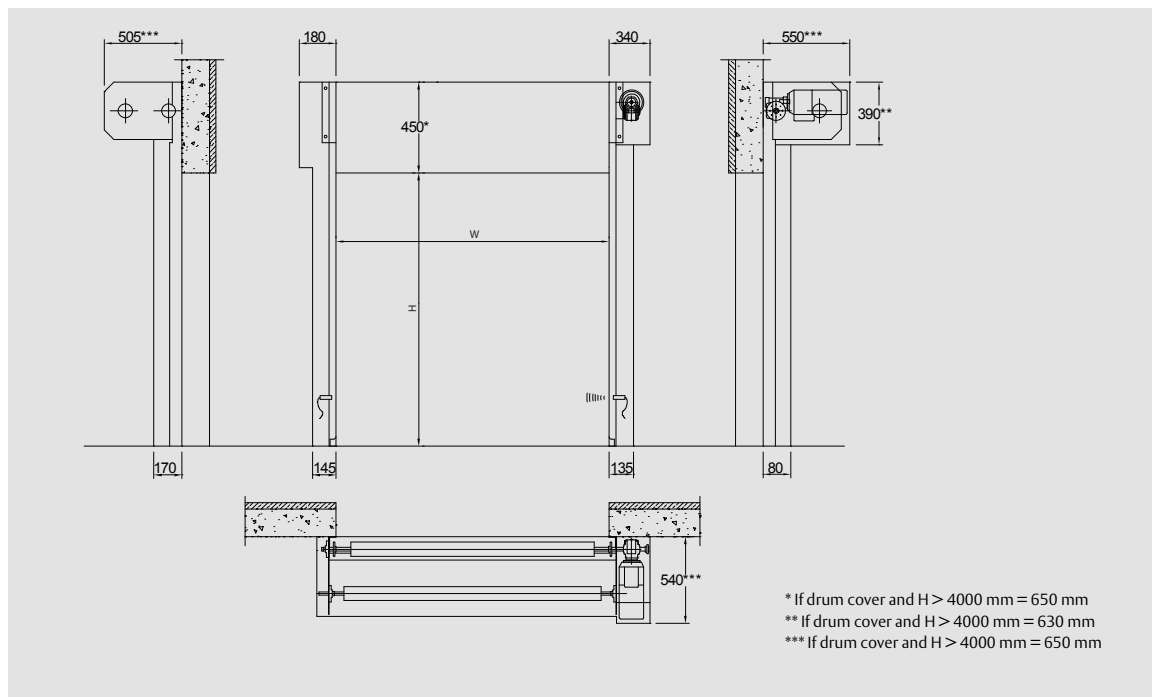



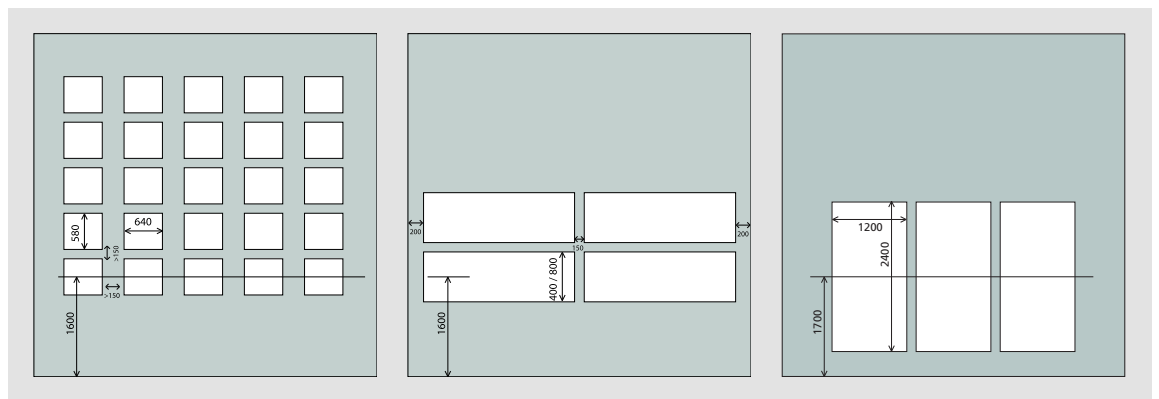



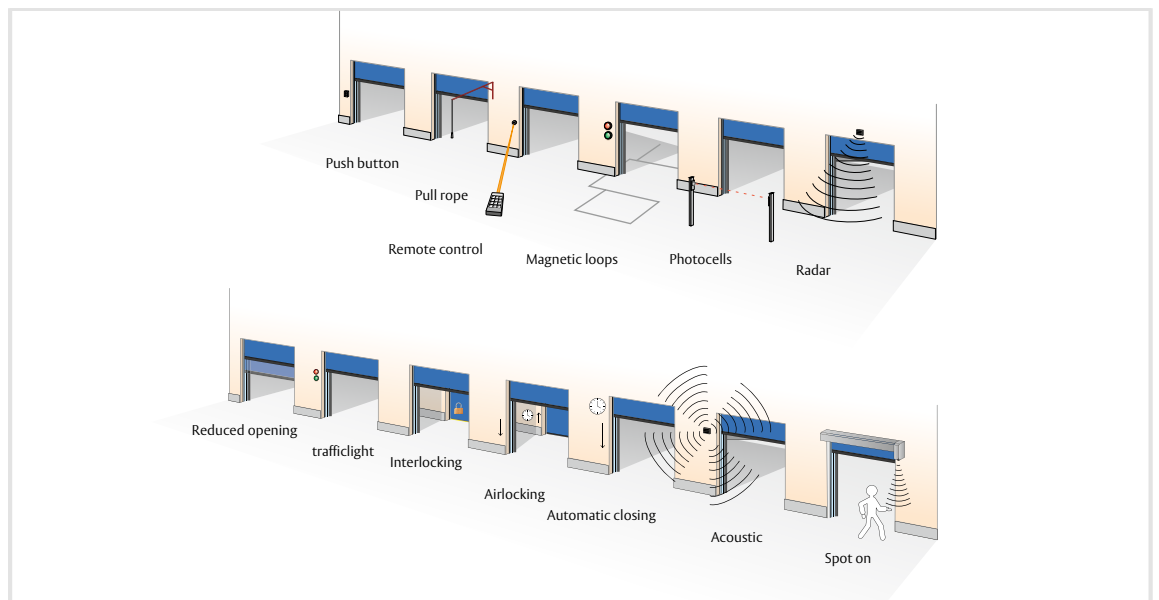





Windows, vision panels and insect screens



Options access and automation



Standard available colors

 Signal yellow RAL 1003	 Ultramarine blue RAL 5002	 Anthracite grey RAL 7016	 Jet black RAL 9005
 Pure orange RAL 2004	 Gentian blue RAL 5010	 Light grey RAL 7035	 White RAL 9010
 Flame red RAL 3000	 Moss green RAL 6005	 Traffic grey B RAL 7043	 On request Other colors